

analyser

the art of measuring

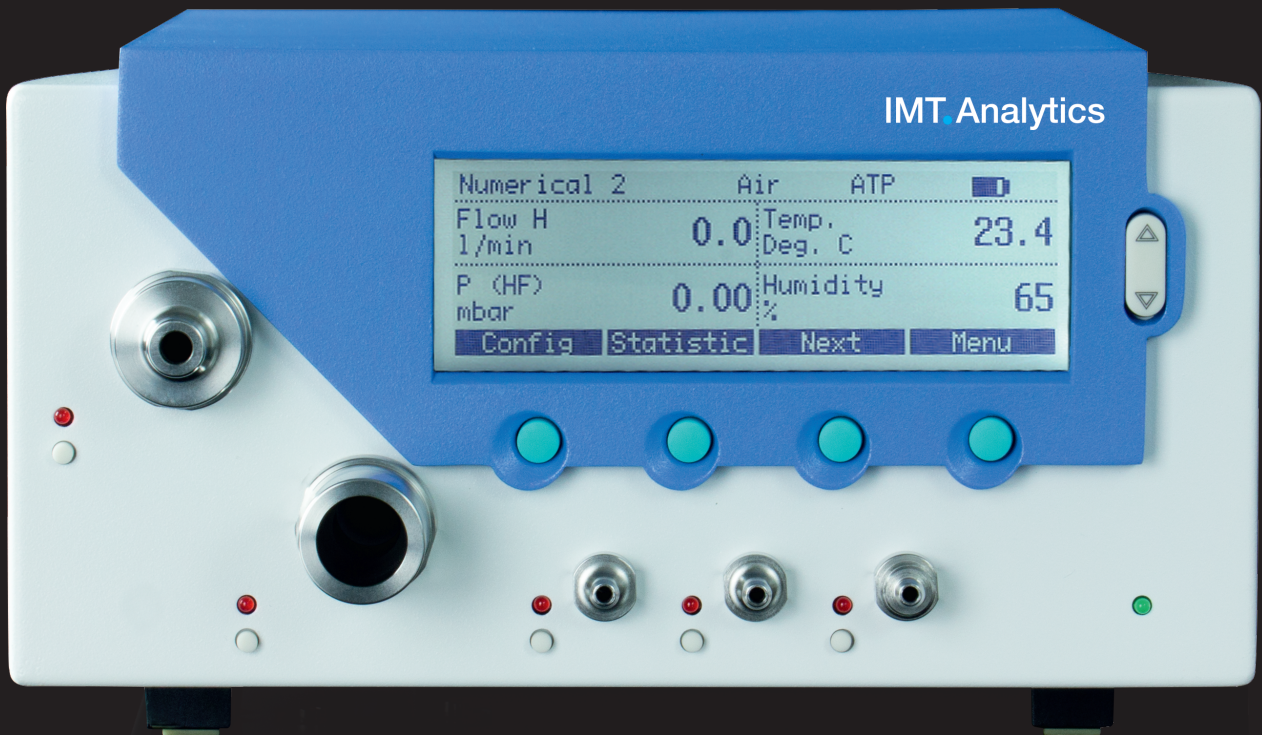

User Manual
FlowAnalyser

IMT Analytics

IMT Analytics AG
Gewerbstrasse 8
9470 Buchs (SG)
Switzerland

www.imtanalytics.com

Table of contents

1	Introduction	5
2	Intended use	6
3	Safety instructions	7
3.1	Representation of hazards, cautions and notes	7
3.2	Personnel	7
3.3	Responsibility and guarantee	7
3.4	Service life	7
4	Specifications	8
4.1	Measurement parameters	8
4.2	Gas standards for flow and volume measurement	11
4.3	Power supply	12
4.4	Battery operation	12
4.5	Directives and approvals	13
4.6	Device labels and symbols	13
4.7	PC minimum requirements	14
5	Start-up	15
5.1	Individual parts in the packaging	15
5.2	Power supply	16
5.3	Mechanical connectors	16
5.4	Electrical interfaces	21
6	Operation	23
6.1	Switching the device on and off	23
6.2	The Start screen	23
6.3	Change contrast	23
6.4	User controls terminology	24
6.5	Specification of user controls	24
6.6	Numerical display	25
6.7	Configuration display	27
6.8	Statistics display	28
6.9	Menu display	29
6.10	Data storage	30
6.11	RT-200 emulation mode	32
6.12	Calibrations	34
6.13	Gas type and standards	36
6.14	Set trigger	37
6.15	Filter	40
6.16	Set language	40
6.17	HW activation	41
6.18	Call up system info	41
6.19	Hidden menu options	42
6.20	Factory defaults	42
7	MultiGasAnalyser OR-703	43
7.1	Description	43
7.2	Use	43
7.3	Warning	43
7.4	Principle	44
7.5	Connection	44
7.6	LED signal	45
7.7	OR sensor calibration	46
7.8	Servicing and care	47
7.9	Technical specifications	47

8	Measuring ventilation ratios	48
8.1	General	48
8.2	Connecting to the ventilator	49
8.3	Standard trigger values	50
8.4	Base flow	50
8.5	Finding the correct trigger values	51
8.6	Special cases	52
9	Servicing and care	54
9.1	Guidelines for servicing and care	54
9.2	Notes about changing parts	54
9.3	Preventive cleaning and servicing routines	54
9.4	Contact	57
10	Accessories and spare parts	58
10.1	Ordering address	58
10.2	Device variants	58
10.3	Options	58
11	Disposal	59
11.1	Disposal	59
12	Appendix	60
12.1	Abbreviations and glossary	60
12.2	Measurement parameters and units	62

1 Introduction

Validity

This documentation is valid for the product with the designation:

- FlowAnalyser PF-300, FlowAnalyser PF-301, FlowAnalyser PF-302
- MultiGasAnalyser OR-703

You will find the name FlowAnalyser on the rating plate on the back of your device.

The **FlowAnalyser** designation used in this manual applies to the models **FlowAnalyser PF-300, FlowAnalyser PF-301 and FlowAnalyser PF-302.**

Software and firmware version

This documentation applies to the following versions:

FlowAnalyser firmware – version 4.3.3 or higher

In the case of older or newer versions there may be minor discrepancies in relation to this User Manual.

Designations used in this User Manual

Buttons and indicators on the display

Buttons such as **Power** and indicators on the display such as **Change Settings** are printed in boldface italics.

References to pages and sections

For references to pages and references, e.g. ([→4.1.6 Physical data](#)), the symbol ([→XY](#)) is used.

2 Intended use

This product is intended for testing and calibration purposes on medical devices or systems that generate gas flows or gas pressures. That includes ventilators and anaesthetic machines. The user of the device has received training on how to use medical equipment and can perform repairs, maintenance and servicing on medical devices. The device can be used in hospitals, in clinics, at device manufacturers or at independent service companies that perform repairs or servicing on medical devices. FlowAnalyser is intended for use in a laboratory environment. It may only be used outside the nursing sector. It must not be used directly on patients or devices that are connected to patients. The measuring instrument FlowAnalyser is intended for over-the-counter sale.

FlowAnalyser is the solution for measurements in the following areas:

- Flow Low (-20–20 L/min)
- Flow High (-300–300 L/min)
- Volume
- Differential pressure
- High pressure
- Ambient pressure
- Oxygen
- Temperature
- Air humidity
- Dew point temperature

In addition, various ventilation parameters can be measured:

- Inspiratory volume, expiratory volume
- Ventilation rate
- I:E
- Inspiratory time, expiratory time
- P_{peak}
- P_{mean}
- P_{plateau}
- PEEP
- PF Insp (inspiratory peak flow)
- PF Exp (expiratory peak flow)
- Ti/TCycle
- Cstat
- Delta P



FlowAnalyser is a measuring instrument for checking and calibrating ventilators and anaesthetic machines. It must not be used for patient monitoring. During patient treatment by the ventilator it is not allowed to connect to FlowAnalyser.

It is not allowed to measure liquids with FlowAnalyser.

This product is intended to be used at elevations of up to 2000 MASL in buildings.

3 Safety instructions

3.1 Representation of hazards, cautions and notes

This User Manual uses the representation below to specifically draw attention to residual risks during intended use and emphasise important technical requirements.



Information and/or instructions and prohibitions to prevent damage of any kind.

3

3.2 Personnel



Work on and with FlowAnalyser may only be performed by persons who have undergone appropriate technical training and have the necessary experience.

3.3 Responsibility and guarantee

The manufacturer accepts no responsibility or guarantee and will exempt itself from liability claims accordingly if the operator or any third parties:

- fail to use the device in accordance with its intended use
- disregard the specifications
- tamper with the device in any way (conversions, modifications, etc.)
- operate the device with accessories that are not listed in the associated sets of product documentation.



Although the device meets high quality and safety standards and it has been constructed and tested according to the current state of the art, it is not possible to rule out the risk of injuries with serious consequences if the device is used in non-compliance with the intended use (improperly) or is misused.

Therefore please read through this User Manual carefully and keep this documentation in a readily accessible place close to your device.

3.4 Service life

The maximum service life of the device has been specified as 10 (ten) years, provided it is handled properly in accordance with this User Manual.

4 Specifications

4.1 Measurement parameters

4.1.1 Measuring instrument values¹

Flow Low	Range Accuracy	-20–20 L/min ± 1.75% of reading or ± 0.04 L/min
Flow High	Range Accuracy	-300–300 L/min ± 1.75% of reading or ± 0.1 L/min
Volume	Range Accuracy	-100–100 L ± 2% of reading ± 0.02 L (Flow High) or ± 0.01 L (Flow Low)
Pressure (at high flow)	Range Accuracy	0–150 mbar ± 0.75% of reading or ± 0.1 mbar
Differential pressure	Range Accuracy	-150–150 mbar ± 0.75% of reading or ± 0.1 mbar
High pressure	Range Accuracy	0–10 bar ± 1% of reading or ± 10 mbar
Ambient pressure	Range Accuracy	0–1150 mbar ± 1% of reading or ± 5 mbar
Oxygen	Range Accuracy	0–100 vol% ± 1 vol%
Humidity	Range Accuracy	0–100% RH (non-condensing) ± 3% RH** from 10% RH to 80% RH ± 5% RH** for <10% and >80% RH
Temperature	Range Accuracy	0–50°C ± 1.75% of reading or ± 0.5°C
Dew point temperature	Range Accuracy	-10–50°C ± 2% of reading or ± 1°C
Additional pressure sensors	For details please refer to the sections → 5.3.6 Low pressure (PF-302 LOW) and → 5.3.7 Pressure sensor ±1bar (PF-301 VAC) .	

¹ Standard litres per minute (converted to STP conditions of 21.1°C and 1013 mbar)

** Absolute tolerance. With steady air flow

4.1.2 Ventilation parameters

V _{ti} , V _{te}	Tidal volume of inspiration and expiration	Range Accuracy	± 10L Flow High: ± 1.75% or 0.20mL (>6.0L/min) Flow Low: ± 1.75% or 0.10 mL (>2.4 L/min)
V _i , V _e	Minute volume of inspiration and expiration	Range Accuracy	± 300 L/min. ± 2.5% or 0.02L (Flow High) 0.01 L (Flow Low)
T _i , T _e	Inspiratory and expiratory time	Range Accuracy	0.05–60s ± 0.02s
T _i /T _{total}	Ratio of inspiratory time to time of a respiratory cycle	Range Accuracy	0–100 % ± 5 %
P _{peak}	Maximum pressure	Range Accuracy	0–150 mbar ± 0.75% or ± 0.1 mbar
P _{mean}	Mean pressure	Range Accuracy	0–150 mbar ± 0.75% or ± 0.1 mbar
I:E	Inspiratory/expiratory ratio	Range Accuracy	1:300–300:1 ± 2.5 %
PEEP	Positive end-expiratory pressure	Range Accuracy	0–150 mbar ± 0.75% or ± 0.1 mbar
Rate	Ventilation rate	Range Accuracy	1–1000 bpm ± 2.5% or ± 1 bpm
PF Insp.	Peak flow during Inspiration	Range Accuracy	± 300 L/min ± 1.75% or ± 0.1 L/min
PF Exp.	Peak flow during Expiration	Range Accuracy	± 300 L/min ± 1.75% or ± 0.1 L/min
C _{stat}	Static compliance	Range Accuracy	0–1000 mL/mbar ± 3% or ± 1 mL/mbar
P _{plateau}	Plateau pressure	Range Accuracy	0–150 mbar ± 0.75% or ± 0.1 mbar
Delta P	Pressure amplitude (P _{peak} – PEEP)	Range Accuracy	0–150 mbar ± 0.75% or ± 0.1 mbar

4.1.3 Principle of flow measurement

Flow in the flow channel is determined by differential pressure measurement. To build up differential pressure a plastic screen is used to provide flow resistance.

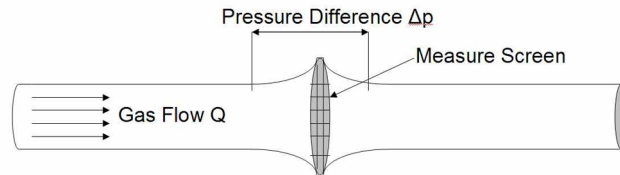

$$\Delta p = c_1 \cdot \eta \cdot Q + c_2 \cdot \rho \cdot Q^2$$

η : dynamic viscosity of the gas [Pa s]

ρ : gas density [kg/m³]

c_1, c_2 : device-specific constants (channel geometry)

Dynamic viscosity

The viscosity of a medium is its resistance to the flow and shear of the current. Viscosity is extremely dependent on temperature. The viscosity of a medium is slightly dependent on the pressure and moisture content of the medium.

Density

Density is the unit for the mass per unit volume of the medium. Density is very dependent on pressure and temperature.

The impact of ambient conditions is hence the reason why flow is occasionally converted to standard conditions.

(→ [4.2 Gas standards for flow and volume measurement](#))

4.1.4 Special functions

Automatic battery operation in the event of a power failure

4.1.5 Communication interfaces

USB, RS-232 port for firmware download, remote control functions and connection to MultiGasAnalyser OR-703 (optional), trigger input (digital) for external trigger

4.1.6 Physical data

Weight: 3.7 kg

Size (l x w x h): 22 x 25 x 12 cm

Gas types: Air, O₂, N₂O, He, N₂, CO₂ and
mixtures: Air/O₂, N₂O/O₂, He/O₂

4.1.7 Calibration by user

Offset calibration of the pressure sensors, calibration of the oxygen sensor.

4.1.8 Operating data

Temperature:	15–40 °C (59–104°F)
Air humidity:	10%–90% RH
Atmospheric pressure:	700–1060 mbar (equivalent to maximum altitude 2000 m.a.s.l.)
Storage and transport conditions:	-10–60 °C (14–140 °F) at 5–95% RH

4.1.9 Extensions

- FlowLab software
- MultiGasAnalyser OR-703

4

4.2 Gas standards for flow and volume measurement

FlowAnalyser converts the flow and volume readings measured in the device to match the conditions of the standard selected. The following gas standards are supported by FlowAnalyser:

Gas standard		Temperature	Pressure	Relative humidity
Ambient Temperature and Pressure	ATP	Current gas temperature	Current Ambient pressure	Current gas humidity
Ambient Temperature and Pressure Dry	ATPD	Current gas temperature	Current Ambient pressure	0%
Ambient Temperature and Pressure Saturated	ATPS	Current gas temperature	Current Ambient pressure	100%
Ambient Pressure at 21 °C	AP21	21.0 °C (70 °F)	Current Ambient pressure	Current gas humidity
Standard Conditions USA	STP	21.1 °C (70 °F)	1013.25 mbar (760 mmHg)	0%
Standard Conditions USA Humid	STPH	21.1 °C (70 °F)	1013.25 mbar (760 mmHg)	Current gas humidity
Body Temperature and Pressure Saturated	BTPS	37 °C (99 °F)	Current ambient pressure and channel pressure (HF) ²	100%
Body Temperature and (Ambient) Pressure Saturated according to ISO 80601-2-12:2011	BTPS-A	37 °C (99 °F)	Current ambient pressure	100%
Body Temperature and Pressure Dry	BTPD	37 °C (99 °F)	Current ambient pressure and channel pressure (HF) ²	0%
Body Temperature and (Ambient) Pressure Dry	BTPD-A	37 °C (99 °F)	Current ambient pressure	0%
Standard condition according to DIN 1343	0/1013	0 °C (32 °F)	1013.25 mbar (760 mmHg)	0%
Standard condition according to ISO 1-1975 (DIN 102)	20/981	20 °C (68 °F)	981 mbar (736 mmHg)	0%

² In order to measure BTPS / BTPD in the Flow Low channel, the rear end of the Flow Low channel has to be connected to the Flow High channel in order to be able to include the temperature and humidity of the Flow High channel. See section ([→5.3.3 Flow Low 1F](#))

Gas standard		Temperature	Pressure	Relative humidity
API Standard Conditions	15/1013	15°C (60°F)	1013.25 mbar (14.7 psia)	0 %
Cummings Standard	25/991	25°C (77°F)	991 mbar (500 ft altitude)	0 %
20°C/1013mbar	20/1013	20°C (68°F)	1013.25 mbar (760 mmHg)	0 %
Normal Temperature and Pressure	NTPD	20.0°C (68°F)	1013.25 mbar (760mmHg)	0 %
Normal Temperature and Pressure, Saturated	NTPS	20.0°C (68°F)	1013.25 mbar (760mmHg)	100 %



In this User manual the unit L/min is based on ambient conditions of 0°C and 1013 mbar (DIN 1343). Please refer to Appendix B: Measurement parameters and units. There you will also find the conversion factors for the units of measurement

4.3 Power supply

Input voltage of the power supply unit: 100–240 VAC (± 10 %), 50–60 Hz
 Supply voltage: 15 VDC, 1.5 A
 Power input: 25 V A

Only use the power supply unit and cable provided!

4.4 Battery operation

Operating time in battery operation: 3 hours
 Operating time in battery operation with MultiGasAnalyser: 2 hours

Charging the battery

A complete charging process takes 8 h. The service life of the battery is extended if the battery is charged completely only after a prompt by the device.



The device indicates visually and audibly when the battery has to be charged. Please do not store the battery in the depleted state. Caution: depletion can damage the battery beyond repair!

4.5 Directives and approvals

- IEC 61010-1
- IEC 61326-1

- CAN/CSA-C22.2 No. 61010-1-12
- UL 61010-1 3rd Edition



The device is classified as Pollution Degree 2.
 The device is classified as Overvoltage Category II.









4











The device is not intended for use outside a building, it is intended for indoor use only.

4.6 Device labels and symbols

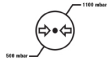
The following labels and symbols can be found on FlowAnalyser and its packaging:

Symbol	Description
	Class II equipment
	For indoor use only
	The device must not be disposed of in household waste
	Alternating current
	Direct current
	Conforms to CE Directives and Regulations
	Mark for United Kingdom Conformity Assessment
	Safety Mark for North America for PF-300
	Safety Mark for North America for Power Supply
	Manufacturer
	The operating instructions should be considered when operating the device
	Warning notice

Symbol	Description
	Serial Number
	Reference Number
	Temperature range for transport and storage
	Humidity range for transport and storage
	Atmospheric pressure for storage and transport
	Keep dry
	Protect from sunlight
 UDI Data Matrix Code (e.g.): 	Unique device identifier (01) GTIN-No. (11) Production Date (21) Serial No.
IP21	Protection class according to standard
Trigger IN	Trigger interface, maximum 24 V, 60 mA

4.7 PC minimum requirements

Intel® Pentium® 4 2.4 GHz
 (Intel® Core TM2 Duo recommended)
 Microsoft® Windows® XP, Vista, 7, 8 (32 bit / 64 bit)
 Microsoft® .NET Framework 3.5 or higher
 128 MB RAM (512 MB recommended)
 160 MB storage space on hard disk (full installation)
 CD-ROM drive
 Monitor 800 × 600 (1024 × 768 recommended)

5 Start-up

5.1 Individual parts in the packaging

	FlowAnalyser
	Power supply (Order No. 300.095.000)
	USB cable
	Calibration certificate
	Filter
	Adapter set

5.2 Power supply

The power supply socket is located at the back of FlowAnalyser. The master switch is used to switch the device on and off. The LED, labelled Charging, is lit when the battery is being charged. This also takes place if the device is switched off.

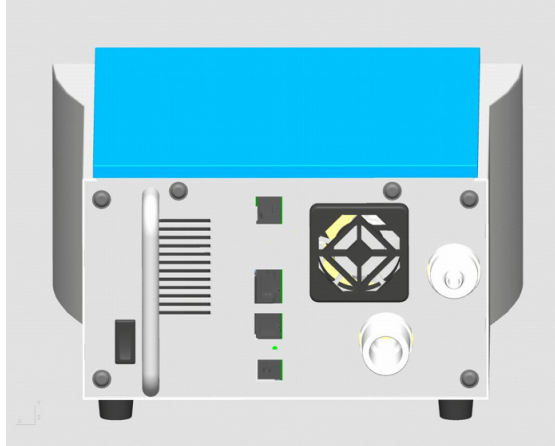

The device can be disconnected from the mains using the power cord. The cord should therefore be easily accessible.

5.2.1 Supply voltage

The mains voltage of the power supply unit included is 100–240 VAC at 50–60Hz.



Before switching on, make sure the operating voltage of the power supply unit agrees with the local mains voltage. You will find this information on the rating plate on the back of the power supply unit.



Only operate FlowAnalyser with the original power supply unit included!

5.3 Mechanical connectors

5.3.1 Filter

To protect the device against soiling due to contaminants and particles in the air the filter included must be used for every measurement of flow (Flow High and Flow Low).



Particles of dirt in the air can clog the measuring system and thus lead to incorrect measurements. The filter must be checked regularly ([→9.3 Preventive cleaning and servicing routines](#)).

5.3.2 Adapter set

The adapters enclosed help to connect the test specimen to FlowAnalyser. Minimising dead volume and differences in the diameter of the flow stream helps to increase the accuracy of measurement. When using the LowFlow channel, the positive connector of the differential pressure sensor is used for pressure measurements. With the tee enclosed and the connecting tube the relevant ports can be connected to one another.

5.3.3 Flow Low³

The Flow Low connector is used for measuring small flows. For calculating the ventilation parameters in this measurement channel the trigger must be set to 'Paediatric' (→8.3 Standard trigger values). The positive connector of the differential pressure sensor will then be automatically used for pressure measurements. To connect the two ports the tee can be used with the connecting tube from the adapter set.

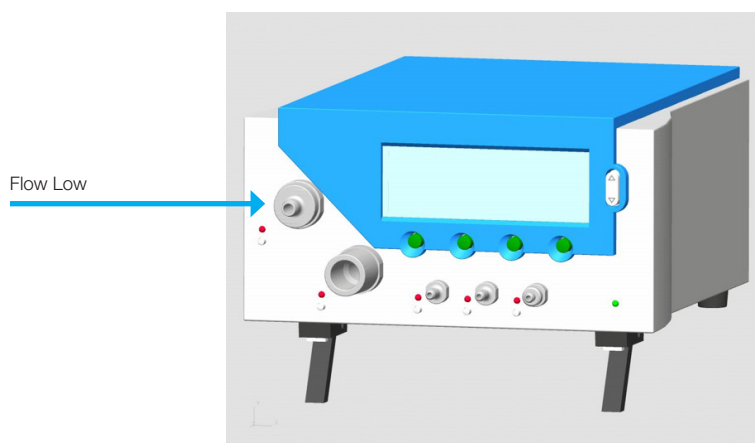

Measuring range: -20–20 L/min

Accuracy: $\pm 1.75\%$ of reading or ± 0.05 L/min



The measurement channel of Flow Low does not have any additional sensors for temperature, air humidity or oxygen concentration. **For flow calculation the current readings are transferred from the Flow High channel.** For accurate measurements it therefore makes sense to connect the Flow Low channel to the Flow High channel using a tube. As a result the missing values can be measured. For flows above 20 L/min measurement in the low flow channel is not accurate enough.

³ Standard litres per minute (converted to STP conditions of 21.1°C and 1013 mbar)

5.3.4 Flow High⁴

The Flow High connector can be used for the following measurements:

- Large flows (-300–300L/min)
- Volume
- Temperature
- Humidity
- Oxygen
- Pressure in the channel

Measurements can be conducted bidirectionally.

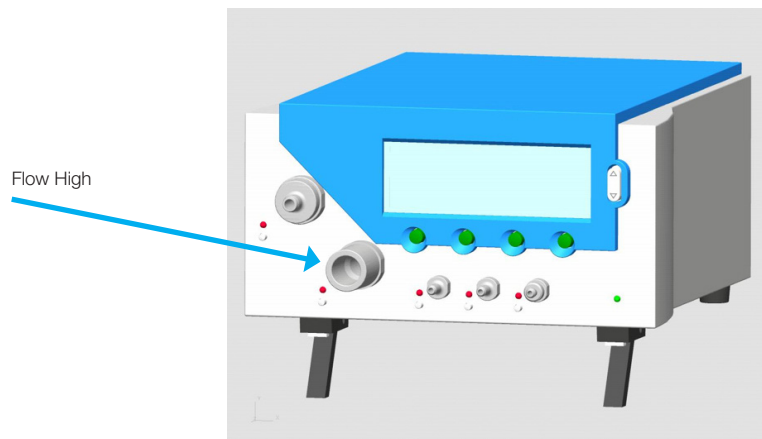

Flow High	Measuring range Accuracy	-300–300 L/min ± 1.75% of reading or ± 0.1 L/min
Volume	Measuring range Accuracy	0–10 L ± 2% of reading or ± 0.02 L
Temperature	Measuring range Accuracy	0–50°C ± 1.75% of reading or ± 0.5°C
Humidity	Measuring range Accuracy	0–100% (non-condensing) ± 3% RH** from 10% RH to 80% RH ± 5% RH** for <10% and >80% RH
Oxygen	Measuring range Accuracy	0–100% ± 1% O ₂
Pressure in the channel	Measuring range Accuracy	0–150 mbar ± 0.75% of reading or ± 0.1 mbar



If work is being performed at a relatively high level of air humidity, care must be taken to ensure that no condensation forms in the device. Water can damage the sensors beyond repair!

⁴ Standard litres per minute (converted to STP conditions of 21.1°C and 1013 mbar)

** Absolute tolerance. With steady air flow

5.3.5 Differential pressure

The Differential pressure connectors can be used for differential pressure measurements.

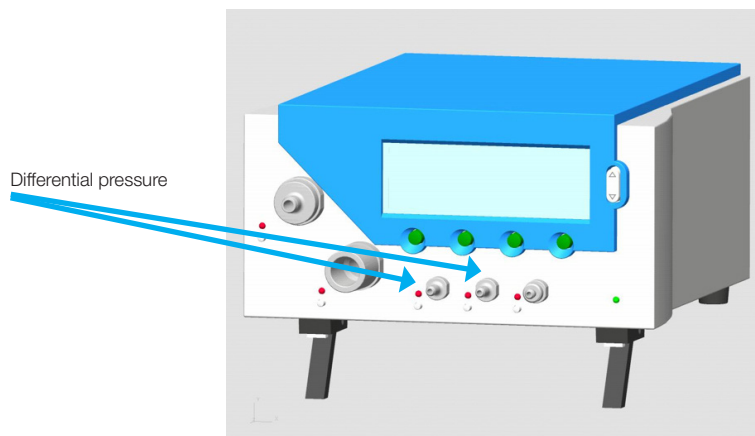

Measuring range: -150–150 mbar
Accuracy: $\pm 0.75\%$ of reading or ± 0.1 mbar

5.3.6 Low pressure (PF-302 LOW)

For PF-302 LOW there is an additional sensor that is connected to the designated port. The connecting nipple is marked with a blue ring.

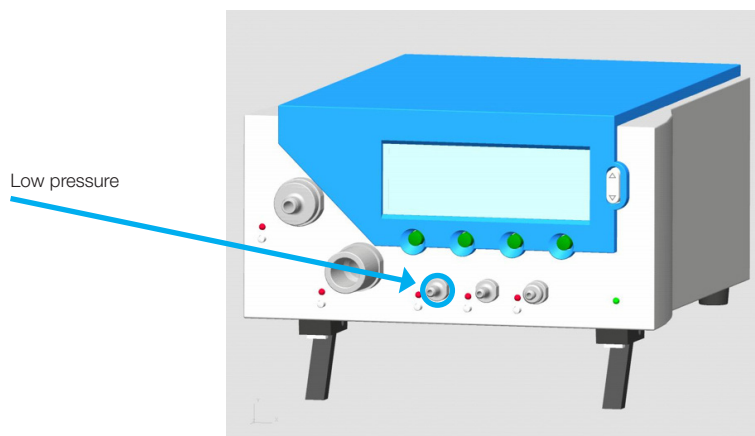

Measuring range: 0–5 mbar
Accuracy: $\pm 1\%$ of reading or ± 0.01 mbar



With the low-pressure variant a port of the differential pressure sensor (± 150 mbar) is connected to the remaining connector and the second one is connected to the environment. The measuring range remains the same.

5.3.7 ± 1 bar pressure sensor (PF-301 VAC)

With FlowAnalyser PF-301 VAC there is an additional ± 1 bar sensor that is connected to the designated port. The connecting nipple is marked with a yellow ring.

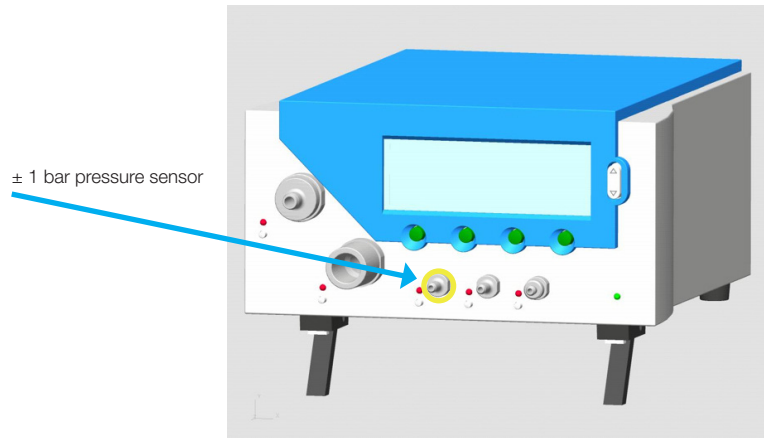

Measuring range: -1000–1000 mbar

Accuracy: $\pm 0.5\%$ of reading or 2 mbar



With the ± 1 bar pressure sensor variant a port of the differential pressure sensor (± 150 mbar) is connected to the remaining connector and the second one is connected to the environment. The measuring range remains the same.

5.3.8 High pressure

The high-pressure port can be used for measuring pressures above 150 mbar. If a DISS-O₂ connector is required for the port, an appropriate adapter can be ordered.

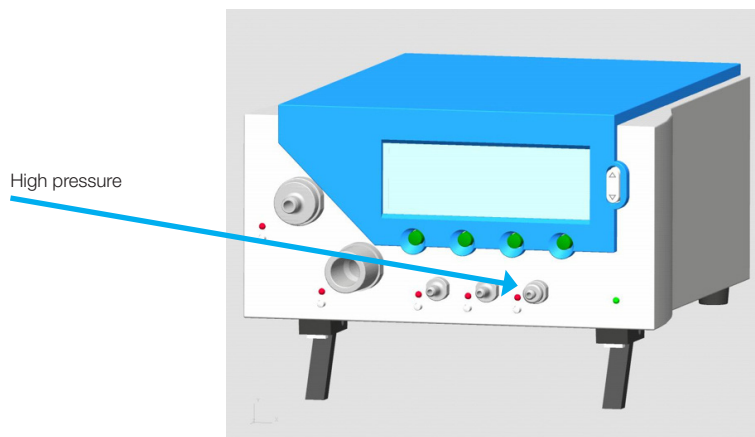

Measuring range: 0–10 bar

Accuracy: $\pm 1\%$ of reading or 10 mbar



With measurements up to 150 mbar it is recommended that the differential pressure connector be used because there the accuracy is up to 100 times higher. Pressures above 15 bar damage the sensor beyond repair!

5.4 Electrical interfaces

5.4.1 USB

The USB port is used for connecting FlowAnalyser to the PC. The port is located at the back of the device.

If the device was ordered together with the FlowLab software, the measured values can be displayed graphically on the computer. On devices without software the USB port is disabled. It can be enabled with an activation code at any time.

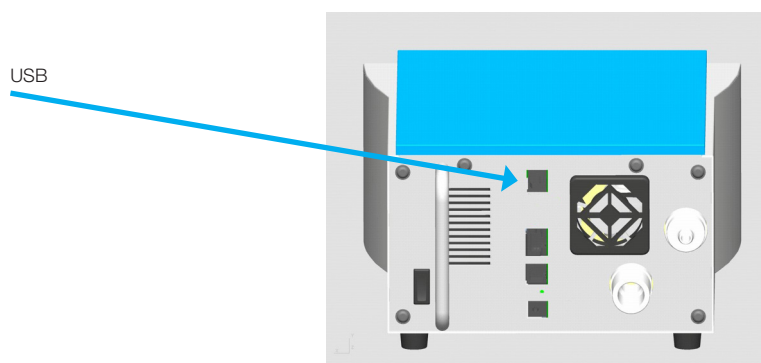

Rating: 5V (+/- 0.25V), max 0.5A

Use only a certified power supply for the computer/notebook which bears a CE, CSA, UL or other equivalent safety mark to ensure double insulation.

5.4.2 RS-232

The RS-232 interface is used for service purposes (firmware download), for connecting to MultiGasAnalyser OR-703 and for external actuation of the device and it is located at the back of FlowAnalyser.

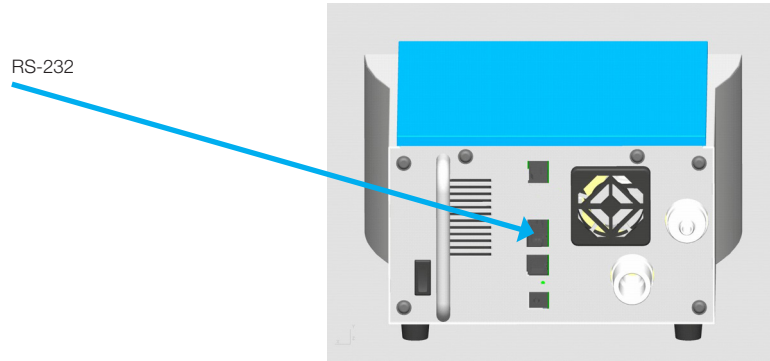

Actuation of the RS-232 port takes place via a special RS-232 cable. If the device is to be actuated via the RS-232 interface, your dealer will be pleased to provide you with a detailed protocol.

FlowAnalyser pin assignment (RJ-45 connector):

Pin 1	+5 V (+/- 0.2V), max 0.5A
Pins 4, 5	GND
Pin 7	TxD
Pin 8	RxD
Pins 2, 3, 6	No connection

5.4.3 Ext. trigger

The external trigger interface is used to start and stop volume measurement and to determine ventilation parameters using an external signal. The input is electrically isolated. A 4-pin cable with an FCC type RJ-10 connector must be used for input.

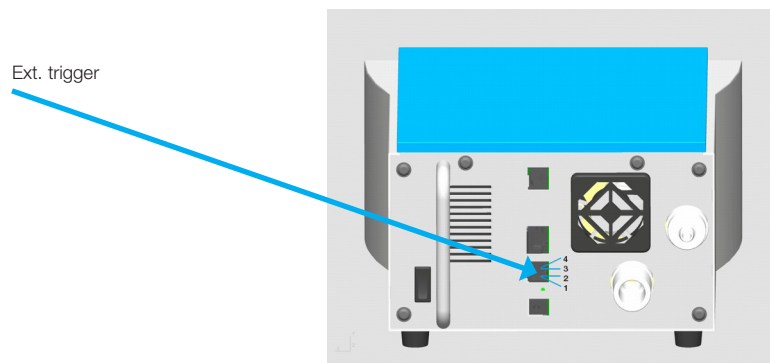

Pin assignment	1, 2	5–24 VDC, max 50 mA
	3, 4	GND

6 Operation

6.1 Switching the device on and off



Check to make sure all the cables and tubes are connected properly and check compliance with the specifications (→5 Start-up)

The device is switched on and off using a 0/1 switch on the back of the device.



6.2 The Start screen

If FlowAnalyser is switched on, the welcome screen appears. After three seconds the display with the numerical readings appears.

If you wish to change the language of the device delivered, please use the language selection function (→6.16 Set language).

6.3 Change contrast

The quality of display depends on the angle of view. To optimise the quality for reading purposes the contrast must be adapted to the angle of view.

Contrast can be adjusted by pressing the two marked buttons simultaneously.

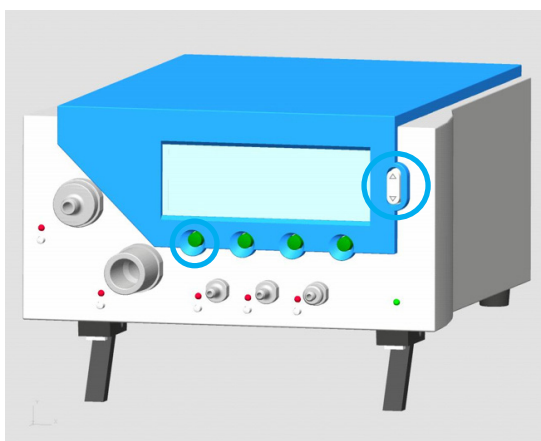

6.4 User controls terminology

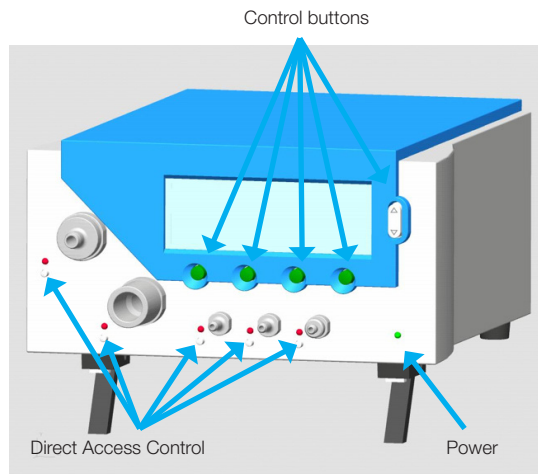

6

6.5 Specification of user controls

Control buttons

The control buttons have not been assigned fixed functions. Allocation of the respective functions is shown on the display.

Direct Access Control (DAC)

Next to each mechanical port there is a Direct Access Control button (DAC). Information associated with the mechanical port, e.g. measurement parameters, value range, present reading, is shown on the display by pressing the relevant DAC. The header of the display also shows the gas type and gas standard. An LED above each DAC indicates whether the relevant port on the display screen is activated.

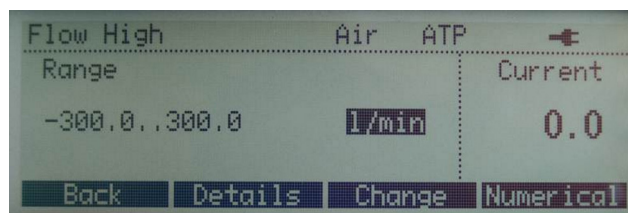

DAC screen of Flow High (Details shows information on the additional sensors in that measurement channel.)

Power



The LED indicates whether the device is switched on.

6.6 Numerical display

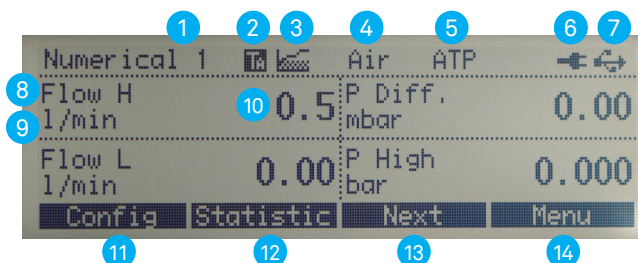
When the device has been switched on, the **Numerical 1** display appears. This display can show four measurement parameters simultaneously. The title bar also shows the currently set gas type, standard, battery charge status, mains operation and USB connection.



6.6.1 Specification of the numerical display

- 1 Number of the numerical display.** In total there are four different numerical displays so up to 16 values can be shown.
- 2 Trigger signal.** This icon indicates when a trigger event occurs during the ventilation currently being measured. This means that the time of appearance of the indicator is identified as the start of inspiration. The indicator appears for ½ second. If this signal does not occur during ventilation, the triggers must be adjusted for the current ventilation mode (→6.14 Set trigger). As long as no trigger event has occurred 'No Tr' is displayed instead of the reading.
- 3 Base flow.** This icon appears if the base flow function has been enabled for volume measurement (→6.14 Set trigger).
- 4** Currently selected **gas type**. The gas type being measured must be set on the device accordingly (→6.13 Gas type and standard).
- 5 Standard.** The readings displayed are converted to the standard indicated. It is possible to select from multiple current gas standards (→6.13 Gas type and standards).
- 6 Power supply.** This icon appears if the device is connected to the power supply. The measuring instrument can also be operated with the integrated battery. This icon appears if the device is being operated from the battery. The icon varies according to the charge status:
 -  Battery full
 -  Battery flat – please charge!
 An audible warning will be heard if the battery is very low (→4.4 Battery operation).
- 7 USB.** The measuring instrument can be connected to the PC using the USB port. The icon appears as soon as a connection to the PC has been established.
- 8 Measurement parameter.** Indicates the measurement parameter currently selected. Measurement parameters can be changed in configuration (→6.7.1 Specification of the configuration display).

- 9 **Unit of measurement.** Indicates the unit of measurement currently selected. Units of measurement can be changed in configuration ([→6.7.1 Specification of the configuration display](#)).
- 10 **Reading.** Indicates the current reading in the selected unit of measurement.
- 11 **config.** You can access the configuration view by pressing the button assigned. There it is possible to change measurement parameters and units of measurement ([→6.7 Configuration display](#))
- 12 **Statistic.** By pressing the button assigned you can access the statistics screen, where minimum, maximum and average values of the various measurement parameters are shown ([→6.8 Statistics display](#)).
- 13 **Next.** With the button assigned you can switch between the four numerical displays.
- 14 **Menu.** Pressing the button assigned causes the Menu display to appear. In the menu you can access gas type, volume trigger, calibrations, language and system info.

6.7 Configuration display

In the total of four configuration displays it is possible to configure the numerical displays. Here it is possible to change the measurement parameters and the associated units of measurement for all four numerical displays.

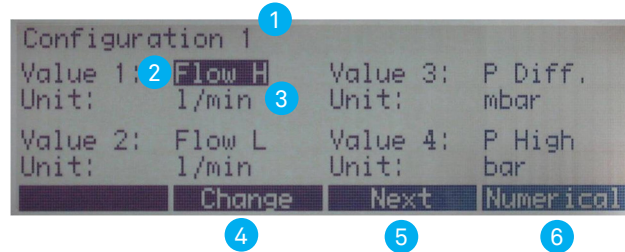

6.7.1 Specification of the configuration display

- 1 **Number** of the configuration display. It is possible to switch between four different configuration displays. The number of the configuration display is the same as the number of the corresponding numerical display.
- 2 **Measurement parameter** that is currently being shown on the numerical display (→ 13 Appendix: Measurement parameters and units). Every value on the display can be marked by pressing the arrow buttons. A red LED draws attention to the corresponding mechanical port.
- 3 **Unit of measurement** in which the measurement parameter is shown on the numerical display (→ 13 Appendix: Measurement parameters and units)
- 4 **Change.** With the associated button you can access edit mode in order to change the relevant measurement parameter or unit of measurement. With Save the new value is applied.
- 5 **Next.** With the button assigned you can switch between the four configuration displays.
- 6 **Numerical.** By pressing the associated button you exit the configuration display and the numerical display reappears.

6.8 Statistics display

In the total of four statistics displays the current values, min, max and average values of the measurement parameters are shown. The measurement parameters on the statistics display correspond to the measurement parameters on the numerical display.

Statistic 1	3	4	5	6
	Cur.	Min.	Max.	Avg.
Flow H	21.9	21.7	22.4	21.9
P (HF) 2	0.00	0.00	0.00	0.00
Temp.	26.5	26.2	26.5	26.5
Humidity	54	54	55	54
Store	Reset	Next	Numerical	

6.8.1 Specification of the statistics display

- 1 **Number** of the statistics display. It is possible to switch between four different statistics displays. The number of the statistics display is the same as the number of the corresponding numerical display.
- 2 **Measurement parameter.** Indicates the measurement parameter currently selected. Measurement parameters can be changed in configuration (→7.7.1 Specification of the configuration display).
- 3 **Current value.** Shows the current reading in the same unit of measurement as on the numerical display.
- 4 **Min.** This value shows the smallest reading that was measured since the last reset.
- 5 **Max.** This value shows the largest reading that was measured since the last reset.
- 6 **Avg.** This value shows the arithmetic mean of all the readings since the last reset. After one minute a sliding average of one minute is shown.
- 7 **Reset.** Pressing the associated button sets the statistical readings to zero. At the same time all the ventilation parameters are reset to 'No Tr'.
- 8 **Next.** With the button assigned you can switch between the four statistics displays.
- 9 **Numerical.** By pressing the associated button you exit the statistics display and the numerical display reappears.
- 10 **Store.** Press this button to save measurement parameters.



On the statistics display the units of measurement are the same as on the numerical display!

6.9 Menu display

On the menu display the following parameters can be viewed or changed:

- Calibrations
- Gas type and standards
- Trigger
- Language
- HW activation
- System info

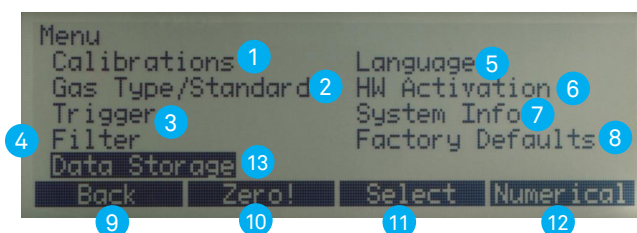

6.9.1 Specification of the menu display

- 1 Calibrations.** In this submenu the oxygen sensor, MultiGasAnalyser OR-703 and all the pressure and flow sensors can be calibrated. With the **Zero!** button it is also possible to start zero calibration for the pressure and flow sensors.
- 2 Gas type/standard.** In this submenu the gas type and standard can be determined (→4.2 Gas standards for flow and volume measurement).
- 3** The settings in the **Trigger** submenu are used for the measurement of volume and ventilation values. By selecting the ventilation mode it is possible to choose standard triggers.
- 4** By selecting a **filter** it is possible to average the readings shown on display over a certain time.
- 5 Language.** Here you can set the required language.
- 6** The **HW activation** submenu shows whether the USB port or communication with MultiGasAnalyser OR-703 has been enabled. If the FlowLab software or MultiGasAnalyser OR-703 was only ordered later, the activation code must be entered here before a connection can be established.
- 7** Under **System info** you will find the software and hardware versions as well as the date of the last factory calibration. Pressing buttons 2 and 3 simultaneously hides all the menu items whose content has an impact on measurements. This can prevent an accidental change in settings.
- 8** Under **Factory defaults** it is possible to restore all the settings to the status when the device was delivered.
- 9 Back** takes you one step back. If you press this button, the numerical display appears in the main menu.

- 10 **Zero** starts a zero calibration for all the pressure and flow sensors. Caution: with this 'fast version' no warnings appear and at the end the device automatically switches to the numerical display.
- 11 **Select.** Pressing the associated button calls up the submenu selected.
- 12 **Numerical.** By pressing the associated button you exit the menu display and the numerical display reappears.
- 13 **Data storage.** Measurement parameters can be saved and viewed.

6.10 Data storage

FlowAnalyser measurements are saved. In addition, the selected gas standard and gas type are automatically saved in the data record.

6.10.1 Storing data

Step 1

Statistic 1				
	Cur.	Min.	Max.	Avg.
Flow H	21.9	21.7	22.4	21.9
P (HF)	0.00	0.00	0.00	0.00
Temp.	26.5	26.2	26.5	26.5
Humidity	54	54	55	54
Store Reset Next Numerical				

1. Call up the statistics display (→6.8 Statistics display)
2. Press **Store** to save the measurement results displayed

Step 2

Data Storage	
Action :	Store
Data No:	8
Back Store Change Numerical	

1. Select the **Data no.** under which you wish to save the readings
2. Press **Store**



If a data record has already been saved under the number you have selected, the new data will automatically replace the old data.

6.10.2 Displaying data

Step 1

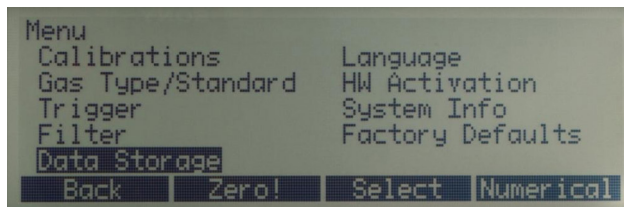

Call up the **menu display** and select **Data storage** (→7.9 Menu display)

Step 2

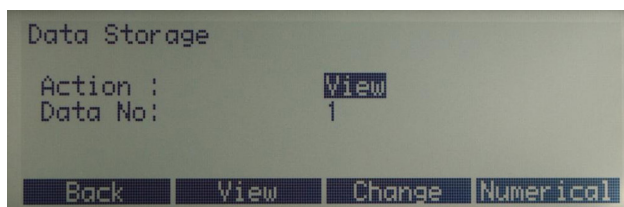

1. Select the **Data no.** that you want to be shown
2. Press **View**

Step 3

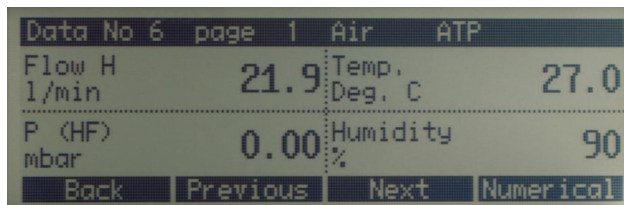

Scroll through the four pages of the data record you have selected by pressing **Previous** and **Next**. As soon as you have viewed all four pages of the data number selected the first page of the next data record appears automatically.

6.10.3 Deleting data

Step 1

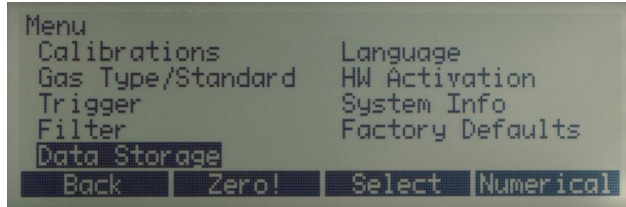

Call up the **menu display** and select **Data storage** (→6.9 Menu display)

Step 2

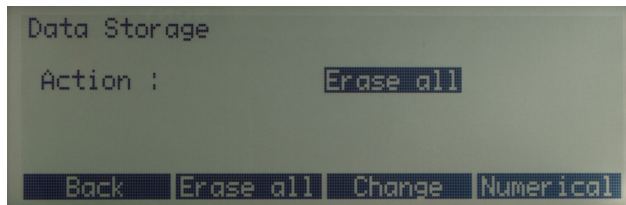

Under **Action** select **Erase all**



If erase has been selected, all the data stored is automatically deleted.

6.11 RT-200 emulation mode

FlowAnalyser has an emulation mode that makes it possible to simulate RT-200 functions via the RS-232 interface (→5.4.2 RS-232).

Step 1

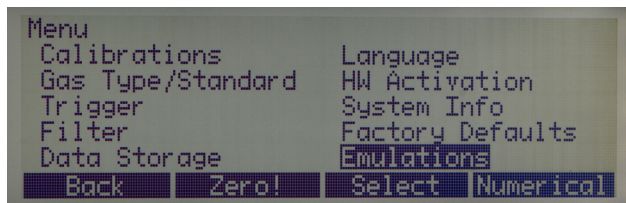

1. Call up the **menu display**
2. Select **Emulations**

Step 2



1. Select **RT-200 emulation**
2. To change the functions select **Functions**

Step 3

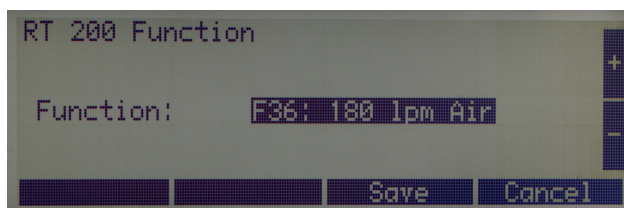

1. Select the function you wish to use as the **measurement basis**
2. Select **Save**
3. Select **Back**

Continuous measuring mode

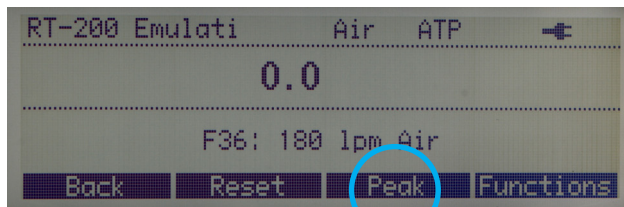

This measuring mode allows you to view ongoing measurements. To switch over to the peak measuring mode select **Peak**.

Peak measuring mode

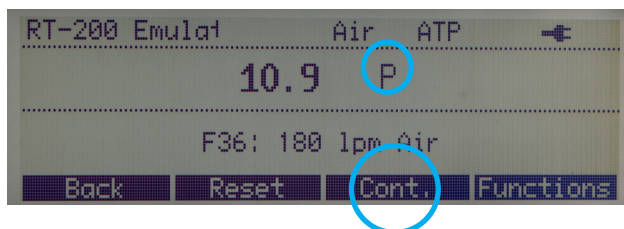

This measuring mode enables you to view the peak values immediately. To switch over to continuous measuring mode select **Cont.**

6.12 Calibrations

In this submenu the oxygen sensor, **MultiGasAnalyser OR-703** and all the pressure and flow sensors can be calibrated / set to zero.

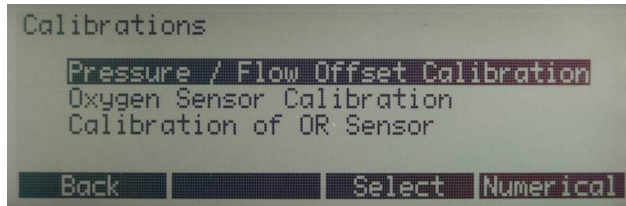

6.12.1 Calibration of pressure and flow sensors

These calibrations are necessary when the display of differential pressure, high pressure or flow through open ports has a value that is greater than or less than zero. This can occur if there are considerable temperature fluctuations.

Calibration resets all the values to zero.



When you have switched on the device, individual displays may deviate slightly from the zero value until operating temperature has been reached (approx. 10 to 15 min). Zero calibration should therefore never be performed with the device cold.



During zero calibration there must be no pressure being applied to a connection port, and care must be taken to ensure that there is no flow through the two measuring channels.

Caution: If calibration is performed with the **Zero!** button, there is no warning of it on the display of the device!

6.12.2 Calibration of the oxygen sensor

The oxygen sensor consists of an electrochemical cell and owing to signs of aging it has to be recalibrated from time to time.

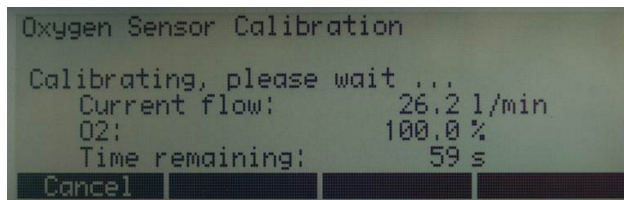

After the start of calibration 100% oxygen and then ambient air have to be applied first, in accordance with the prompt by the device. In both steps it is important for an adequate amount of the corresponding gas to flow through the main measuring channel for a sufficient period of time. For this reason calibration takes approx. 75 seconds per gas. The optimal flow is 20 to 30L/min and it must not be changed during calibration.



Any modifications to the measuring screen of the Flow High or Flow Low channel will mean that flow measurement has to be recalibrated. This recalibration can only be performed at the manufacturer's or at an accredited testing body.

6.12.3 Calibration of MultiGasAnalyser OR-703

Please observe the special section on this ([→8.7 OR sensor calibration](#)).

6.13 Gas type and standards

Depending on the gas that is to be measured, the corresponding gas type must be set on FlowAnalyser beforehand.

The following gas types are available for selection:

- Air (100%)
- Air/O₂-Man. (Air/oxygen mixture according to manual input. The default is 100% O₂)
- Air/O₂-Auto.(Air/oxygen mixture according to sensor measurement of internal oxygen cell)
- N₂O/O₂-Man. (Nitrous oxide / oxygen mixture according to manual input. The default is 100% O₂)
- N₂O/O₂-Auto. (Nitrous oxide / oxygen mixture according to sensor measurement of internal oxygen cell)
- Heliox (21% O₂)
- He/O₂-Man. (Helium/oxygen mixture according to manual input. The default is 100% O₂)
- He/O₂-Auto.(Helium / oxygen mixture according to the sensor measurement of internal oxygen cell)
- N₂ (100%)
- CO₂ (100%)

By pressing **Change** you can switch between the various requirements and **Save** applies the value selected. In the case of mixtures with manual input of O₂ concentration the latter can be adjusted in addition.

Standard conditions are understood to mean defined conditions for pressure, temperature and, in some cases, humidity, which constitute the basis for converting the flow actually measured. Therefore it is essential to check which standard condition the value displayed relates to.

The standard currently set is indicated on the numerical display ([→5.2 Gas standards for flow and volume measurement](#)).

If you press **Change** a plus and a minus appear, so you can switch between the various requirements. **Save** applies the value selected.



A gas that has not been selected properly and a gas standard that has not been selected properly can lead to measuring errors of up to 20%.

6.14 Set trigger

The start and stop of volume calculation and determination of the ventilation parameters are controlled by trigger events. A trigger event can be caused by flow or pressure in the flow channel (→9 Measuring ventilation ratios).

6.14.1 Selection of ventilation mode

By selecting the ventilation mode it is possible to usefully preselect triggers. With these standard values 90% of measuring tasks can be solved.

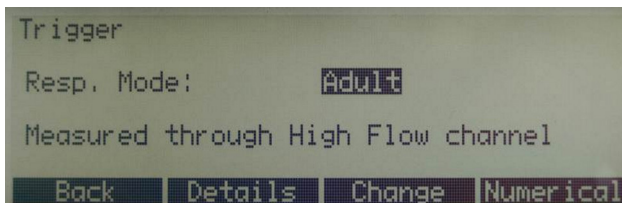

You can choose between the following ventilation modes:

- Paediatric ventilation (This measurement takes place using the Flow Low channel, whereby pressure measurement is conducted at the Pdiff port)
- Adult ventilation
- High-frequency ventilation

6.14.2 Standard triggers

For each ventilation mode the set trigger values are saved. By pressing **Reset** the values can be reset to the standard values at any time.

Standard trigger for paediatric ventilation

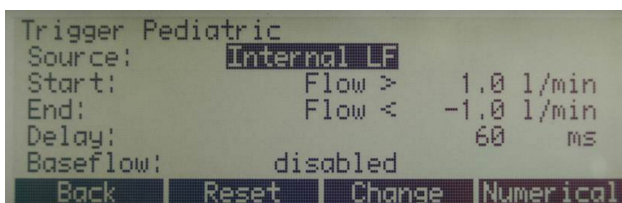

The measurement of paediatric ventilation takes place using the Flow Low channel. The required pressure measurement is performed using a tee on the Pdiff port.

If the **Paediatric** trigger mode is set, pressure compensation is automatically enabled for the Flow Low channel.

Standard trigger for adult ventilation



Standard trigger for high-frequency ventilation

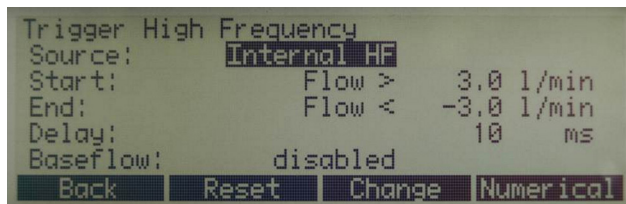

6.14.3 Detail settings

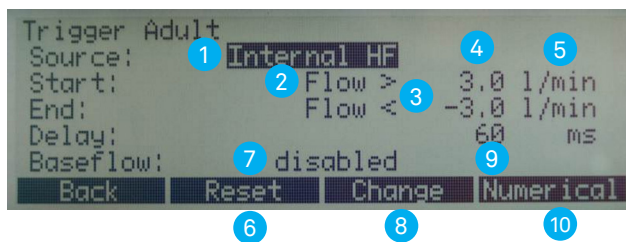

- 1 **Measurement channel.** Here the measurement channel is selected on the one hand (HF = Flow High channel; LF = Flow Low channel). On the other hand you specify whether internal readings (pressure or flow) will be used as triggers or whether an external trigger is to be used (→6.14.4 Using an external trigger)
- 2 **Measurement parameter** of the start and stop trigger. You can choose between pressure and flow.
- 3 **Trigger edge**
 > Positive edge (rising curve)
 < Negative edge (falling curve)
- 4 **Trigger threshold.**
 As soon as this value is exceeded or undershot, volume measurement starts or stops. The value must be within the range of -250...250 L/min (Flow High channel) or -15...15 L/min (Flow Low channel).
- 5 **Unit of measurement** of the selected measurement parameter for start and stop trigger.

- 6 **Reset.** By pressing the assigned reset button the standard trigger values are loaded for the flow trigger. Volume measurement is possible in most cases with these settings (→8.3 Standard trigger values).
- 7 **Base flow.** Base flow can be switched on and off here. Base flow is a constant flow that must not be included in the calculation. If this function is selected, an appropriate icon appears on the display (→7.6 Numerical display).
- 8 **Change.** With the associated button you can access edit mode in order to change the relevant measurement parameter.
- 9 **Delay.** Delay prevents an individual spot from causing a trigger event. If a trigger value is undershot or exceeded again within the delay time, the trigger is regarded as invalid and there is a further wait for an effective trigger. In high-frequency ventilation the delay is set down by default.
- 10 **Numerical.** By pressing the associated button you exit the statistics display and the numerical display reappears.

6.14.4 Using an external trigger

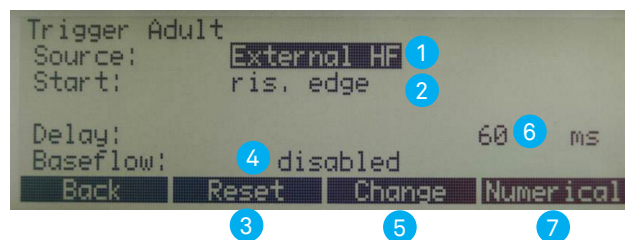

- 1 **External.** For volume calculation an external trigger signal is used (→5.4.3 Ext. trigger).
- 2 **Start.** You can determine whether volume measurement is to take place with a rising or falling signal edge.
- 3 **Reset.** By pressing the assigned reset button the default values are loaded for the flow trigger. Volume measurement is possible in most cases with these settings.
- 4 **Base flow.** Here you can specify base flow. Base flow is a constant flow that must not be included in the calculation. If this function is selected, an appropriate icon appears on the display (→6.6 Numerical display).
- 5 **Change.** With the associated button you can access edit mode in order to change the relevant measurement parameter.
- 6 **Delay.** Delay prevents an individual spot from causing a trigger event.
- 7 **Numerical.** By pressing the associated button you exit the statistics display and the numerical display reappears.

6.15 Filter

The display of FlowAnalyser is refreshed every 0.5 seconds but measurement takes place every 5 ms. Without a filter the current reading is shown every time the screen display is refreshed.

Since a measurement always has a certain amount of noise, it is useful, over a certain time, to average the readings recorded at a very high speed. This can be accomplished with the filter function.

The following filters are selectable:

- None (indication of the last value measured without any threshold)
- Low (mean above 240 ms)
- Medium (mean above 480 ms)
- High (mean above 960 ms)

A mean filter is used by default.

By pressing **Change** you can switch between the various filters with the arrow buttons and **Save** applies the filter selected.



This filtering of readings only has an impact on the values shown on the display of FlowAnalyser.

In the FlowLab software it is always the raw, unfiltered readings that are displayed.

6.16 Set language

The display can be shown in different national languages. The existing languages are continuously checked and updated.

By pressing **Change** you can switch between the various languages with the arrow buttons and **Save** applies the value selected.

6.17 HW activation

The HW activation submenu indicates whether the USB port or communication with MultiGasAnalyser OR-703 has been enabled.

If the **FlowLab** software or MultiGasAnalyser OR-703 was added later, an activation code must be entered in order to enable use of these options.

You can obtain this code from your dealer or by contacting IMT Analytics with an email (sales@imtanalytics.com).

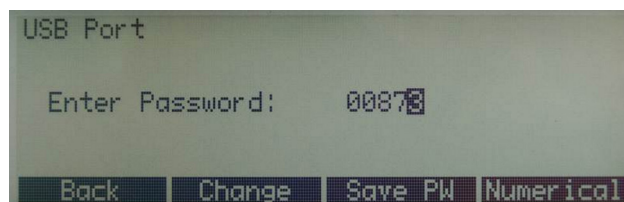

Press **HW activation** to enter. Now various numbers appear which can be selected with the arrow buttons. With **Change** each one can be set to the required value and applied with **Save**.

By pressing **Save PW** the code is applied and on the screen **one** appears if the correct code has been entered. Please enter the code right-aligned and leave superfluous digits at 0.

6.18 Call up system info

Here the following information is shown:

- Software version
- Hardware version
- Date of the last factory calibration
- Serial number of the device

6.19 Hidden menu options

In the **System Info** menu it is possible to hide menu items whose settings have an impact on the measurement result. This can prevent an accidental change in settings.

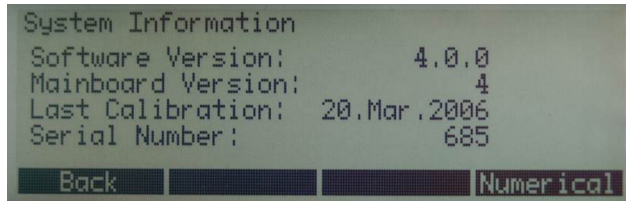

Pressing buttons 2 and 3 simultaneously hides the menu items gas type / standard, trigger, filter and HW activations.

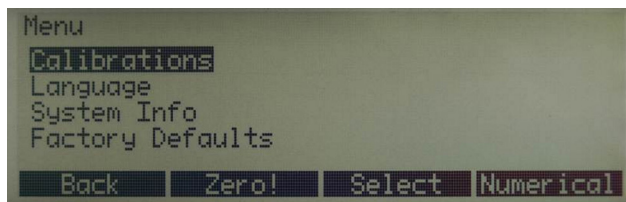

To show all the menu items again press buttons 2 and 3 in the **System Info** menu.

6.20 Factory defaults

Under **Factory defaults** it is possible to restore all the settings to the status when the device was delivered.

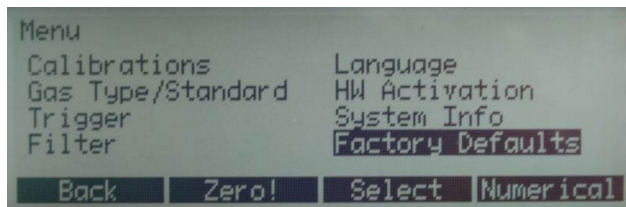

The new values must be enabled by switching the device off and back on again.

7 MultiGasAnalyser OR-703

7.1 Description

MultiGasAnalyser OR-703 consists of a 10-channel infrared (NDIR) gas sensor, a barometric pressure sensor, a CPU and an RS-232 Interface.

This User Manual describes the specifications of the red model of MultiGasAnalyser OR-703. If you have any questions about the blue model, please contact our Technical Support.

The sensor can measure the following gas concentrations:

- Carbon dioxide (CO₂)
- Nitrogen oxide (N₂O)
- Halothane (HAL)
- Enflurane (ENF)
- Isoflurane (ISO)
- Sevoflurane (SEV)
- Desflurane (DES)

The concentrations of CO₂, N₂O and two of the five anaesthetic gases can be measured at the same time.

7.2 Use

MultiGasAnalyser OR-703 is designed to perform, in conjunction with FlowAnalyser, to perform gas measurements for the calibration and testing of anaesthesia systems and facilities.

The sensor is **not** suitable for monitoring patients.

The sensor is **not** suitable in conjunction with applications that are parts of means of transport such as cars or aircraft.

7.3 Warning



MultiGasAnalyser OR-703 may only be used by professionally trained personnel.

MultiGasAnalyser OR-703 may not be used with flammable anaesthetic agents.

Used airway adapters that have to be discarded must be disposed of in accordance with local waste disposal regulations for biologically contaminated liquids.

Measurements can be detrimentally affected by RF radiation, e.g., by cellphone communication.

Care must be taken to ensure that MultiGasAnalyser is only operated in an EMC-specified environment.

7.4 Principle

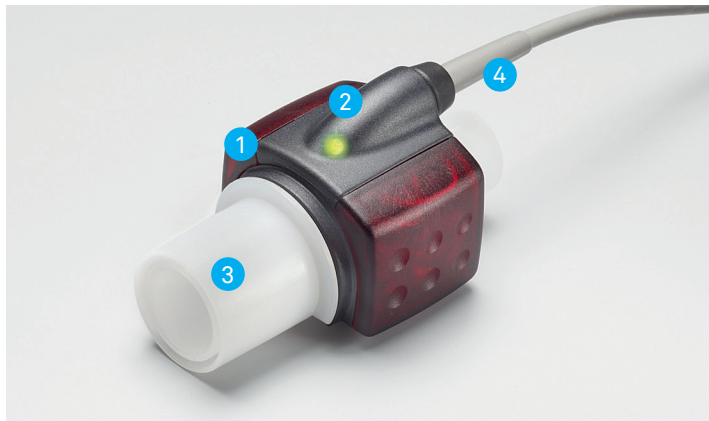

MultiGasAnalyser OR-703 consists of an OR sensor head **1**, an O₂ sensor cell (optional) **2**, an airway adapter **3** and a connecting cable **4**.

The OR sensor head is located on the top of the airway adapter. The sensor head contains all the optical components that are required for measuring all the gases.

Since all the calibration data is stored in the relevant sensor head, it is possible to change the sensors without recalibration.

Concentration measurement and identification of gases by absorption of up to ten different infrared wavelengths.

7.5 Connection

The OR sensor first has to be connected to the RS-232 input of FlowAnalyser (at the back).

Attached the OR sensor to the airway adapter from above. If it is in the correct position, the sensor will click into place. Wait 15 minutes before the first measurement until the sensor has warmed up.



A green LED indicates that the sensor is ready for operation.



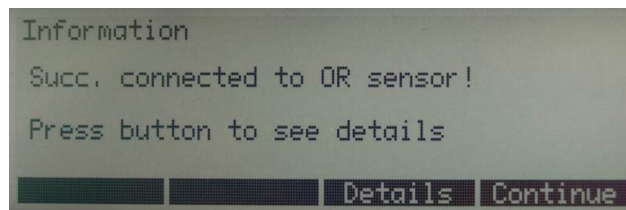

This screen information indicates that a connection between FlowAnalyser and the OR sensor has been successfully established.

Details lists all the technical details concerning the sensor.

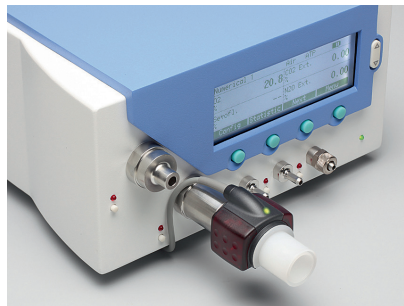

The sensor must always be operated with the LED facing up.

MultiGasAnalyser must be placed between the gas source and FlowAnalyser.

Depending on the direction of flow, MultiGasAnalyser can be operated at the front or rear flow channel port of FlowAnalyser.

7.6 LED signal

The LED located on the sensor head of MultiGasAnalyser indicates the following status information:

Continuous green light	System OK
Continuous blue light	Anaesthetic agent exists
Continuous red light	Sensor error
Flashing red light	Please check the adapter
Flashing green light	Calibration of the OR sensor

7.7 OR sensor calibration

Ambient air calibration of the infrared measurement should be performed at regular intervals and after any replacement of the airway adapter.

The need for ambient air calibration is indicated on the monitor by an alarm message 'Calibration of OR Sensor!'. (After calibration the message disappears).

Ambient air calibration can also be performed if an offset is found in the gas measurements. The gas measurements should be checked with a reference measuring instrument. Calibration is performed by attaching a new airway adapter to the OR sensor. The airway adapter must not be connected to the air circuit. Then the calibration procedure begins in the menu of FlowAnalyser (→6.12.3 Calibration of MultiGasAnalyser OR-703). If the sensor is in the correct position, it will click into place. Before continuing, please wait 30 seconds because the sensor has to warm up first.

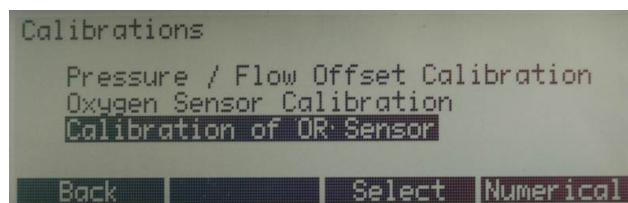

If the airway adapter is being replaced, a zero calibration must be performed. If the airway adapter is being replaced, a zero calibration must be performed.

It is important to ensure that during calibration there is no flow through the airway adapter. For successful ambient air calibration it is essential to have ambient air conditions (21% O₂ and 0% CO₂)!

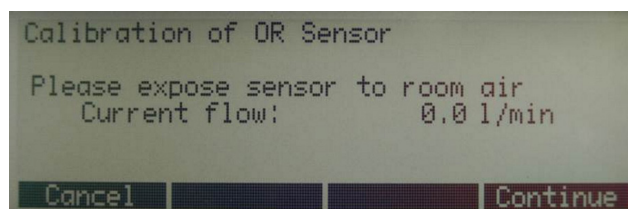

After calibration the readings should always be checked in order to obtain correct readings with certainty during subsequent measurements.

7.8 Servicing and care

MultiGasAnalyser is non-sterile. Autoclaving, sterilisation and immersion in liquid can cause serious damage to the sensor. The sensor can be cleaned with a cloth moistened with ethanol or isopropyl alcohol.

The airway adapter must be changed at least every 12 months. If MultiGasAnalyser is used in a sterile system, a new sterile adapter must be fitted.

Gas measurements should be checked regularly using a reference measuring instrument.

For this purpose IMT Analytics AG offers a service to recertify the measuring accuracy of the sensor.

7.9 Technical specifications

Physical data	Dimensions (L × W × H)	38 × 37 × 34 mm 1.49 × 1.45 × 134 inches	
	Weight	<25 g (not including cable)	
	Cable length	2.50 m ±0.02	
Ambient conditions	Operating temperature	10–40°C, 50–104°F	
	Storage temperature	-20–50°C, -4–122°F	
	Air humidity (operation)	10–95% RH, non-condensing	
	Air humidity (storage)	5–100% RH, condensing	
	Atm. pressure (operation)	700–1200 hPa	
Accuracy specifications (under standard conditions)	Gas	Range	Tolerance
	CO ₂	0–15 vol%	± (0.2 vol% + 2 % of reading)
		15–25 vol%	unspecified
	N ₂ O	0–100 vol%	± (2 % vol% + 2 % of reading)
	HAL, ISO, ENF	0–8 vol%	± (0.15 vol% + 5 % of reading)
		8–25 vol%	unspecified
	SEV	0–10 vol%	± (0.15 vol% + 5 % of reading)
		10–25 vol%	unspecified
DES	0–22 vol%	± (0.15 vol% + 5 % of reading)	
	22–25 vol%	unspecified	
Rise times (@ 10 L/min)	CO ₂ < 90 ms N ₂ O, HAL, ISO, ENF, SEV, DES < 300 ms		
Monitoring	Numerical measurement data and real time graph representation with FlowLab software.		

Deviations from gas setting stated. For example, 50 vol% helium typically reduces the CO₂ values by 6%. This means that a measured mixture consisting of 5.0 vol% CO₂ and 50 vol% helium is equivalent to a measured concentration of $(1-0.06) * 5.0 \text{ vol\%} = 4.7 \text{ vol\% CO}_2$.

8 Measuring ventilation ratios

8.1 General

To measure ventilation ratios it is essential that FlowAnalyser can read a ventilation cycle from the measured pressure and / or flow graphs. This is controlled using the triggers.

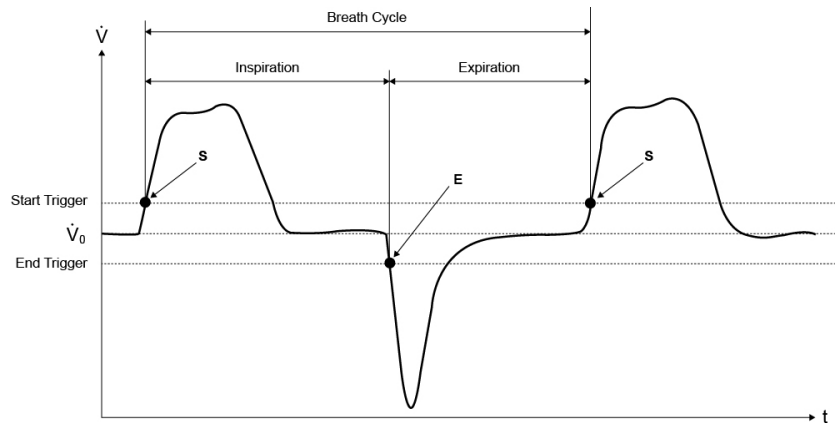

Correct definition of the start and stop triggers is therefore of major importance and it can have a considerable impact on the measurement results.

For triggering the ventilation cycles the set triggers are used (→6.14 Set trigger).

It is therefore very important for the triggers to be set correctly before the measurement of ventilation ratios is started.



The start trigger is interpreted as the beginning of the inspiratory phase.

The stop trigger is interpreted as the end of the inspiratory phase and as the beginning of the expiratory phase. Expiration continues until the next start trigger.

8.2 Connecting to the ventilator

Basically there are three different variants for how FlowAnalyser can be connected to the ventilator:

A: Downstream of the Y-piece

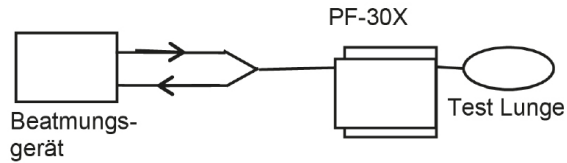

Note: It is advisable to have the inspiratory flow entering from the front (positive direction) and the expiration entering from the back (negative direction) of the unit.

If this is not the case trigger settings have to be modified for proper breath detection. With default trigger settings inspiration becomes expiration and several parameters will be calculated wrongly or not at all.

B: In the inspiratory channel upstream of the Y-piece

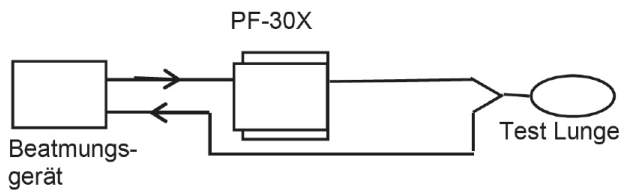

Note: default trigger settings require modification.

C: In the expiratory channel upstream of the Y-piece

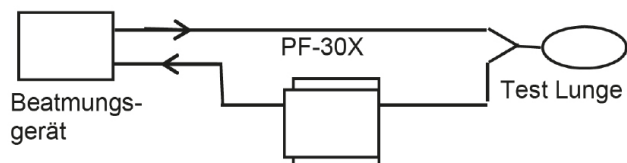

Note: default trigger settings require modification.

8.3 Standard trigger values

Since FlowAnalyser is able to measure flows in both directions of flow, it makes sense to prefer connection variant A. With this measurement setup the flow is normally selected as the trigger parameter. For this reason the flow triggers are stored in the device as standard values and they can be restored at any time. The standard trigger values for the flow trigger in adult ventilation are as follows, for example:

- Start trigger: Flow > 3 L/min
- End trigger: Flow < -3 L/min

You will find the other standard values in the Operation section: ([→6.14.2 Standard trigger](#)).

With connection variants B and C it is usually the pressure that is selected as the trigger signal. In this case the standard requirements are as follows:

- Start trigger: Pressure > 1 mbar
- End trigger: Pressure < 1 mbar

8.4 Base flow

Base flow is a constant flow that must not be included in volume calculation.

If, for example, a system has a defined leak, resulting in a continuous discharge of 3 L/min air, those 3 L/min are not included in the inspiratory volume. By entering

- Base flow: on 3.0 L/min

the volume calculation could be corrected in our example.

8.5 Finding the correct trigger values

If you are setting a trigger for the first time, it is important to know the characteristic of the signal that will be used for the trigger (flow or pressure). It is therefore advisable to analyse that characteristic with the FlowLab software first. Graphically it is then very easy to decide where the triggers should be placed.

In the following we will now show a few examples that also point to potential problems.

8.5.1 Flow curve downstream of the Y-piece

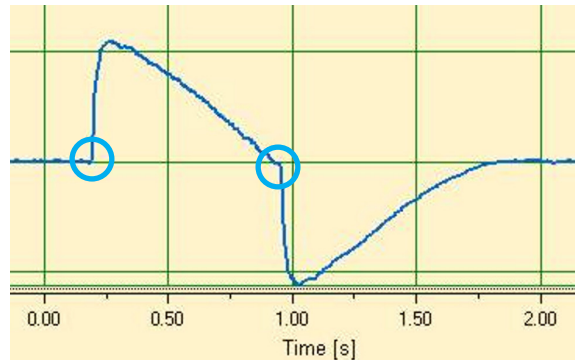

This example shows a flow curve downstream of the Y-piece. The standard triggers ($> 3 \text{ L/min}$ / $< -3 \text{ L/min}$) can be used in this case without any problems.



In such a situation it is important to ensure that the trigger is significantly above the noise of the baseline or else false triggering can be caused.

8.5.2 Flow curve upstream of the Y-piece

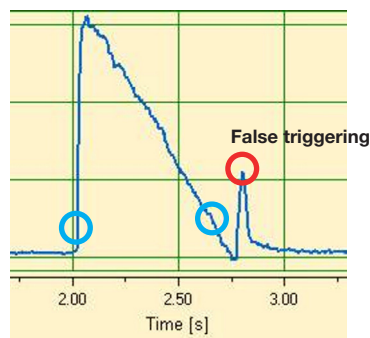

This graph shows the flow curve in the inspiratory channel upstream of the Y-piece. The first two circles indicate the triggers that should be used in this case.

The illustration above shows that at this measuring point after inspiration a small false signal is still visible which was generated by switching over the valves. This leads to false triggering!



Here the flow must not be used as a trigger! The pressure curve must be used instead ([→8.5.3 Pressure curve upstream of the Y-piece](#)).

8.5.3 Pressure curve upstream of the Y-piece

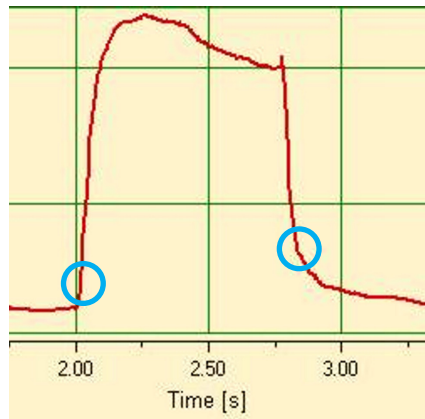

Now here the standard triggers can again be used for the pressure curve: (> 1 mbar / < 1 mbar).



Naturally here too it is important to ensure that the trigger is significantly above the noise of the baseline. Otherwise the trigger value must be increased.

In the FlowLab software it is very easy to determine with the aid of the cursor where the trigger should be placed ([→7.5.3 Cursor](#)).

8.6 Special cases

Basically, in measuring technology it is always possible to deviate from the standard variant in order to achieve an even more accurate result. However, it must be borne in mind that with the settings discussed so far it is possible to achieve very accurate results that surpass the accuracy of all ventilators.

Measuring errors due to the system as a whole occur both in the ventilator and in FlowAnalyser. However, the values indicated can vary because what was measured and compared may not be exactly the same.

8.6.1 Inspiratory volume V_{ti}

If the ventilation curve has a plateau or a pause, a very small flow can nevertheless be measured during that time. Many ventilators do not include these small flows in the calculation of V_{ti} . With the following trigger settings this can also be prevented in FlowAnalyser:

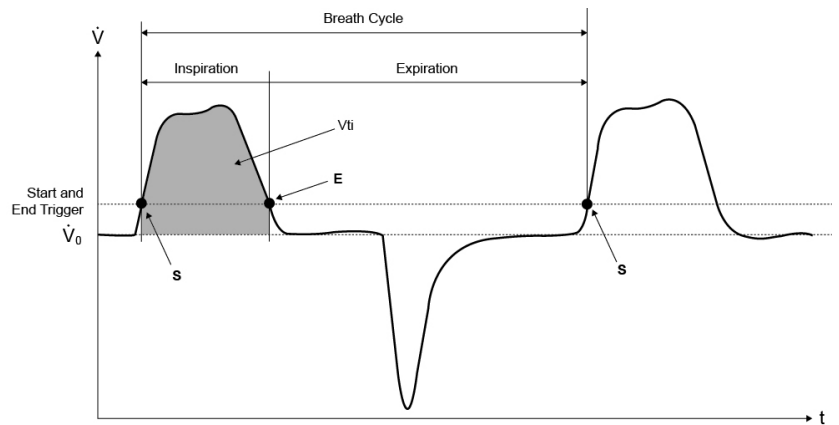

S on this chart represents the start trigger and E represents the end trigger.

8.6.2 Expiratory volume V_{te}

Here is the analog setting for V_{te} :

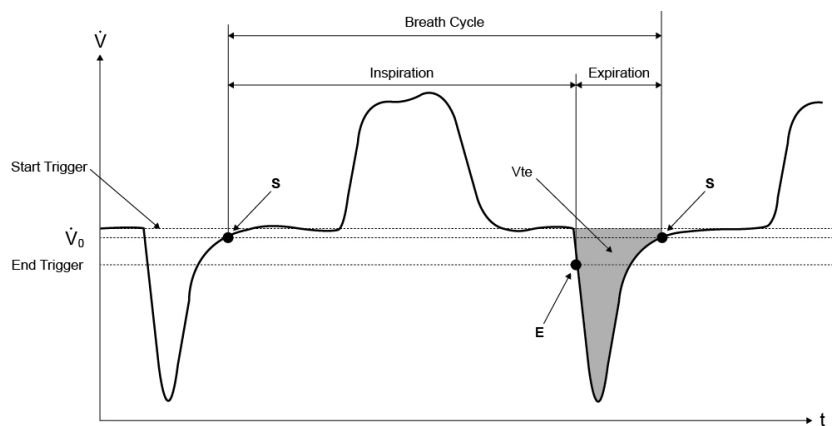

Here too the start trigger should be placed at S and the end trigger should be placed at E

9 Servicing and care

9.1 Guidelines for servicing and care

Careful servicing in compliance with the instructions is essential for ensuring that FlowAnalyser operates safely and efficiently. Only components recommended by the manufacturer may be used.



It is absolutely essential to comply with the guidelines and servicing instructions issued by the various manufacturers.

9.2 Notes about changing parts



The servicing operations listed below may only be performed by persons who are familiar with FlowAnalyser. All further repair work may only be performed by authorised trained professionals. Please also observe the information issued by the various manufacturers.

9.3 Preventive cleaning and servicing routines

To ensure that your device operates with precision and reliability for as long as possible, it is essential to perform the following servicing routines regularly:

During operation

Use of the filter included

Every four weeks

Visually check the protection filter for dust or contamination. Replace the filter if contamination is visible.

Every 12 months:

Factory calibration to ensure reliable measurement. To have FlowAnalyser calibrated at the manufacturer's, IMT Analytics, visit the website www.imtanalytics.com/easycal

9.3.1 Replacing measuring screens

Replacement of the measuring screens must be followed by recalibration of flow measurement. This can only be performed by the manufacturer or an accredited test laboratory.

9.3.2 Replacing the oxygen sensor

To be able to replace the oxygen sensor the hood must be removed:



Using the appropriate tool, undo screws 1 and 2 that fasten the hood.

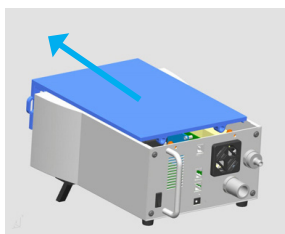

Carefully slide the hood to the front by a certain amount

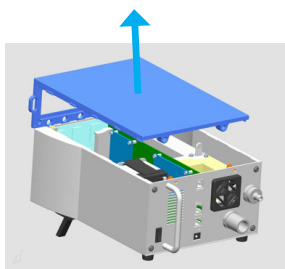

Lift off the hood

The oxygen sensor is located inside the measuring instrument.

1. Remove the connector from the oxygen sensor.
2. Remove the oxygen sensor by turning it anticlockwise.
3. Screw a new oxygen sensor into the block clockwise and reattach the connector.
4. Refit the cover.
5. Calibrate the oxygen sensor (→6.12.2 Calibration of the oxygen sensor)

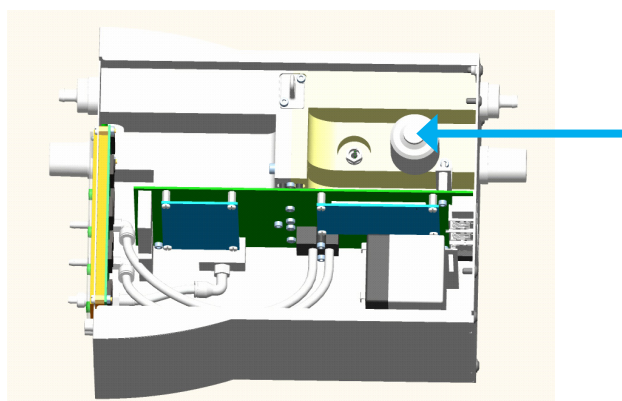

9.3.3 Replacing the fuses

To replace the fuses the back panel must be removed:

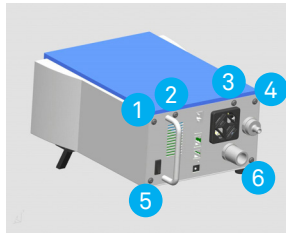

Using the appropriate tool undo screws 1–6 that fasten the back panel.

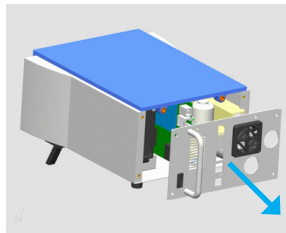

Carefully move the back panel to the rear. Please do not damage the cable connections

The two fuses are located on the pc board inside FlowAnalyser.

1. Disconnect battery
2. Remove faulty fuse
3. Insert new fuse
4. Refit the back panel.

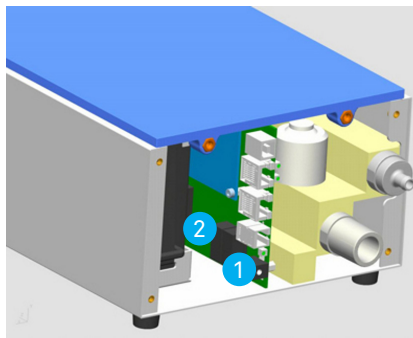

- 1 250 VAC, 300 VDC, 1.25 A F, 5 × 20 (external supply 18V)
- 2 250 VAC, 300 VDC, 1.25 A F, 5 × 20 (internal supply 12V)



Only use the spare parts recommended by the manufacturer (→10 Accessories and spare parts).

9.4 Contact

If you have any questions or problems please contact one of the offices listed below.

9.4.1 Manufacturer's name and address

IMT Analytics AG
Gewerbstrasse 8
CH-9470 Buchs
Switzerland

Tel: +41 (0)81 750 67 10

Email: sales@imtanalytics.com

9.4.2 Technical support

Tel: +41 (0)81 750 67 10

Email: techsupport@imtanalytics.com

10 Accessories and spare parts

10.1 Ordering address

IMT Analytics AG
Gewerbstrasse 8
CH-9470 Buchs
Switzerland
Tel: +41 (0)81 750 67 10
Email: sales@imtanalytics.com

10.2 Device variants

Article	Ordering code
FlowAnalyser PF-300	300.116.000
FlowAnalyser PF-301 VAC	300.116.001
FlowAnalyser PF-302 LOW	300.116.002

10.3 Options

Article	Ordering code
FlowLab software	900.015.000
MultiGasAnalyser OR-703	500.041.000
SmartLung Adult	300.162.100
SmartLung Infant	300.400.104
EasyLung	300.756.100

11 Disposal

11.1 Disposal

Disposal of the device is the operator's responsibility. The device can

- be delivered, carriage free and duty paid, to the manufacturer for disposal.
- be handed over to a licensed private or public collection company.
- be professionally broken down into its constituent parts by the operator and be recycled or disposed of in accordance with regulations.

In the case of self-disposal the disposal regulations are country-specific and are contained in relevant laws and ordinances. These codes of conduct must be obtained from the authorities responsible.

In this context, wastes must be recycled or destroyed ...

- without endangering human health
- without using processes or methods that harm the environment, especially water, air, soil, animals and plants
- without causing noise or odour nuisances
- without having a detrimental effect on the surroundings or landscape.

12 Appendix

12.1 Abbreviations and glossary

A	
A	Ampere
AC	Alternating Current
AT	Ampere, slow-blow
B	
bar	1 bar = 14.50 psi
Base flow	Base flow is a constant flow that must not be included in volume calculation.
C	
°C	Degrees Celsius Conversion from Celsius (C) to Fahrenheit (F): $F = 9 \times C / 5 + 32$
Cstat	Static Compliance
D	
dBA	Decibels measured with A filter
DC	Direct Current
DIN	Deutsche Industrienorm (German Industrial Standard)
DAC	Direct Access Control
Delta P	Pressure amplitude (P _{peak} – PEEP)
E	
EMC	Electromagnetic Compatibility
F	
°F	Degrees Fahrenheit Conversion from Fahrenheit (F) to Celsius (C): $C = (F - 32) \times 5 / 9$
FCC RJ-10	Connector for external trigger (telephone connector according to FCC registration, U.S. Federal Communications Commission; RJ = 'Registered Jack')
G	
GND	Ground
H	
Hz	Hertz (1 Hz = 1 s ⁻¹)
H	Hour
HF	High Frequency
I	
IP	Protection class according to standard
I:E	Inspiratory/expiratory ratio
L	
L	Litre
lbs	Pounds
LED	Light emitting diode
L/s	Litres per second
L/min	Standard litres per minute (converted to ambient conditions of 0°C and 1013 mbar)

M

Max, max	Maximum
mbar	Millibar (1 mbar = 10 ⁻³ bar)
Min	Minute
Min, min	Minimum
min.	At least
mm	Millimetre (1 mm = 10 ⁻³ m)
mL	Millilitre (1 mL = 10 ⁻³ L)

P

ppm	Parts per million (1×10 ⁻⁶)
prox.	Proximal
psi	Pounds per square inch (1 bar = 14.50 psi)
Ppeak	Peak pressure
Pmean	Mean pressure
PEEP	Positive end-expiratory pressure
PF Insp.	Maximum flow during inspiration
PF Exp.	Maximum flow during expiration
Pplateau	Plateau pressure at the end of inspiration

R

RH	Relative Humidity
RS-232	Serial interface
RJ-10 FCC	Connector for external trigger (telephone connector according to FCC registration, U.S. Federal Communications Commission; RJ = 'Registered Jack')

T

Ti/TCycle	Ratio of inspiratory time to time of a respiratory cycle
-----------	--

V

V	Volt
VA	Apparent power input of the device
VAC	Volts Alternating Current
VDC	Volts Direct Current
Of the rdg.	Of the reading

µm	Micrometre (1 µm = 10 ⁻⁶ m)
----	--

12.2 Measurement parameters and units

12.2.1 Pressure readings

Measurement parameter	Designation	Units of measurement
Ambient pressure	P Amb.	mbar, bar, inH ₂ O, cmH ₂ O, psi, Torr, inHg, mmHg, hPa, kPa
Pressure high	P High	
Pressure in Flow High channel	P (HF)	
Differential pressure	P Diff.	

12.2.2 Flow readings

Measurement parameter	Designation	Units of measurement
Flow High	Flow H	L/min, mL/min, cfm, L/s, mL/s
Flow Low	Flow L	L/min, mL/min, cfm, L/s, mL/s

12.2.3 Meteorological readings

Measurement parameter	Designation	Units of measurement
Temperature	Temp.	°C, K, °F
Humidity	Humid.	%
Oxygen content	O ₂	%
Dew point	Dew point	°C, K, °F
Volume	Vol. (HF)	mL, L, cf

12.2.4 Gas concentrations

Measurement parameter	Designation	Units of measurement
Gas concentration	Gas concentration	%
Partial pressure	Partial pressure	mbar, bar, inH ₂ O, cmH ₂ O, psi, Torr, inHg, mmHg, hPa, kPa

12.2.5 Ventilation values

Measurement parameter	Designation	Units of measurement
Positive end expiratory pressure	PEEP	mbar, bar, inH ₂ O, cmH ₂ O, psi, Torr, inHg, mmHg, hPa, kPa
Mean pressure	P _{mean}	
Maximum pressure	P _{peak}	
Plateau pressure	P _{plateau}	
Pressure amplitude	Delta P	

Measurement parameter	Designation	Units of measurement
Minute volume Expiration	Ve	L/min, mL/min, cfm, L/s, mL/s
Minute volume Inspiration	Vi	
Inspiratory peak flow	PF Insp.	
Expiratory peak flow	PF Exp.	
Expiratory volume	Vte	mL, L, cf
Inspiratory volume	Vti	mL, L, cf
Ventilation rate	Rate	Breaths/min
Inspiratory/expiratory ratio	I:E	-
Expiratory time	Te	s
Inspiratory time	Ti	s
Compliance	Cstat	mL/mbar, L/mbar, mL/ cmH ₂ O, mL/cmH ₂ O

12.2.6 Conversion factors

1 mbar	equals	0.001	bar
		100	Pa
		1	hPa
		0.1	kPa
		0.75006	torr (760 torr = 1 atm.)
		0.75006	mmHg (at 0°C)
		0.02953	inHg (at 0°C)
		1.01974	cmH ₂ O (at 4°C)
		0.40147	inH ₂ O (at 4°C)
		0.01450	psi, psia

1 bar	equals	1000	mbar
		0.1	Pa
		1000	hPa
		100	kPa
		750.06	torr (760 torr = 1 atm.)
		750.06	mmHg (at 0°C)
		29.53	inHg (at 0°C)
		1019.74	cmH ₂ O (at 4°C)
		401.47	inH ₂ O (at 4°C)
		14.50	psi, psia

IMT.Analytics

IMT Analytics AG . Gewerbestrasse 8 . 9470 Buchs . Switzerland
T +41 81 750 67 10 . www.imtanalytics.com